

Ventil - tilluft

KIR

**Beskrivelse**

Ventil som anvendes for tilluft.

Designet for montering i loft.

Ventilen er forsynet med en sektorplade til at retningsbestemme luften. Pladen kan demonteres.

KIR ventilen monteres direkte i Lindab-rør ved hjælp af ventilrammerne VGU eller VRGL og på faconstykker ved hjælp af VRGM eller VEPF.

Vedligeholdelse

De synlige dele kan aftørres med en fugtig klud.

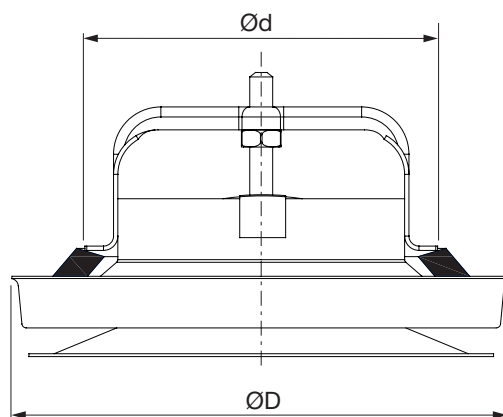
Dimensioner

Ød nom	ØD [mm]	m [kg]
100	141	0,28
125	174	0,42
160	215	0,60

Bestillingskode

Produkt	KIR	100
Dimension Ød		

Materiale

Lakeret, galvaniseret stålplade.

Farve

Hvid RAL 9003, glans 30, eller Hvid RAL 9010, glans 30

Ventil - tilluft

KIR

Tekniske data

Uden Sektorplade

Volumenstrøm, q [l/s] og [m^3/h],
totaltrykfald, Δp_t [Pa],
kastelængde, $l_{0,2}$ [m], og
A-vægtet lydeffektniveau, L_{WA} [dB(A)], for forskellige indstillinger, a [mm], vises i diagrammerne.

Maximal vertikal højde, b_v [m] og
maksimal horisontal bredde b_h [m]
vises i tabellerne overfor.

Lydeffektniveau i oktav bånd, L_{Wok} [dB],

bliver beregnet som $L_{Wok} = L_{WA} + K_{ok}$.
 K_{ok} vises i tabellerne nedenfor.

Ød nom	Ventil monteret i	Middelfrekvens [Hz]							
		63	125	250	500	1K	2K	4K	8K
100	Kanal	-	-6	-2	-3	-5	-8	-9	-15
125	Kanal	-	0	1	-1	-5	-15	-21	-33
160	Kanal	-	3	2	-1	-6	-15	-23	-36

Tolerance	-	±3	±2	±2	±2	±2	±2	±2	±3
-----------	---	----	----	----	----	----	----	----	----

Egendæmpning ΔL , [dB]

Ød nom	Ventil monteret i	Middelfrekvens [Hz]							
		63	125	250	500	1K	2K	4K	8K
100	Kanal	22	18	13	11	9	8	7	8
125	Kanal	20	16	11	9	9	7	6	5
160	Kanal	18	14	10	9	9	7	6	6

Tolerance	±6	±3	±2	±2	±2	±2	±2	±2	±3
-----------	----	----	----	----	----	----	----	----	----

Indregulering

Indreguleringsdata for kontrol af luftmængden findes i
installationsvejledning.

Stråleudbredelse

Maksimal vertikal højde, b_v [m]:

Indstilling a [mm]	Δt	
	±0 °C	-10 °C
4	$b_v = 0,04 \cdot l_{02}$	$b_v = 0,064 \cdot l_{02}$
12	$b_v = 0,04 \cdot l_{02}$	$b_v = 0,075 \cdot l_{02}$



Maksimal horisontal bredde, b_h [m]:

Indstilling a [mm]	Δt	
	±0 °C	-10 °C
4	$b_h = 2 \cdot l_{02}$	$b_h = 2 \cdot l_{02}$
12	$b_h = 2 \cdot l_{02}$	$b_h = 2 \cdot l_{02}$

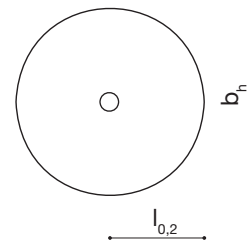

Ventil - tilluft

KIR

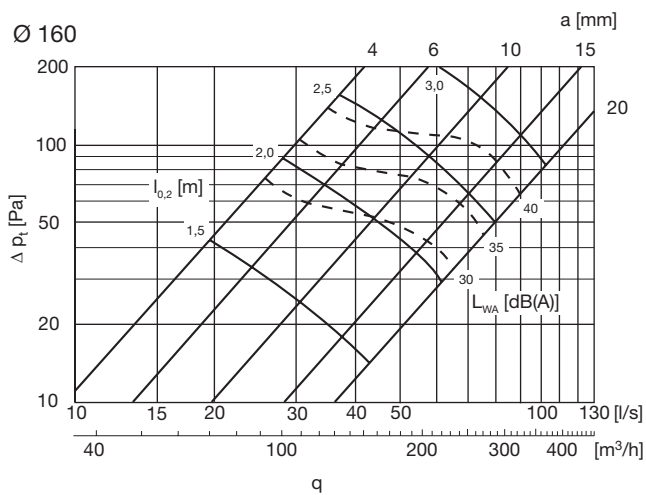
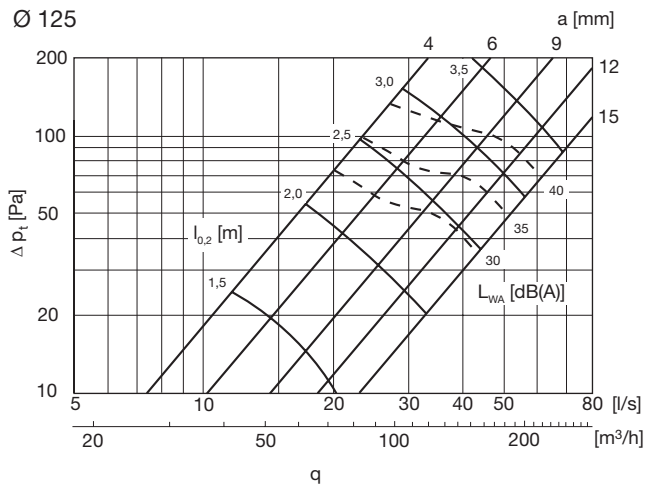
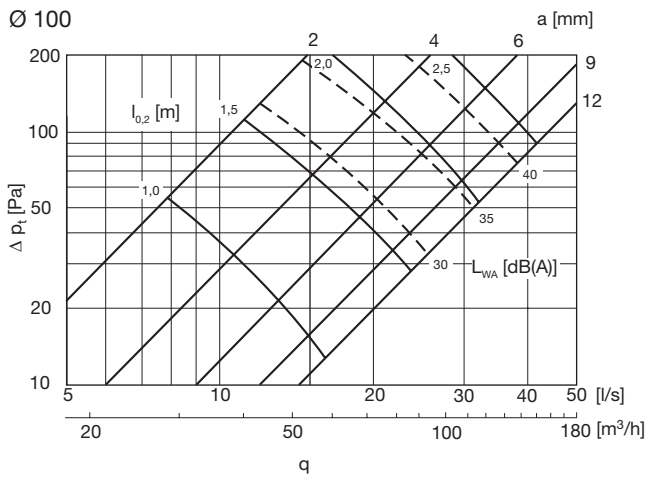

Ventil - tilluft

KIR

Tekniske data

Med sektorplade

Volumenstrøm, q [l/s] og [m³/h],
 totaltrykfald, Δp_t [Pa],
 kastelængde, $l_{0,2}$ [m], og
 A-vægtet lydeffektniveau, L_{WA} [dB(A)],
 for forskellige indstillinger, a [mm], vises i tabellerne.

Maksimal vertikal højde, b_v [m] og
 Maksimal horisontal bredde, b_h [m],
 vises i tabellerne.

Lydeffektniveau i oktav bånd, L_{Wok} [dB],

bliver beregnet som $L_{Wok} = L_{WA} + K_{ok}$.
 K_{ok} vises i tabellerne nedenfor.

Ød nom	Ventil monteret i	Middelfrekvens [Hz]							
		63	125	250	500	1K	2K	4K	8K
100	Kanal	-	-2	-2	-4	-6	-8	-8	-16
125	Kanal	-	-1	-1	-1	-4	-12	-19	-33
160	Kanal	-	3	0	-2	-5	-10	-21	-35

Tolerance	-	±3	±2	±2	±2	±2	±2	±2	±3
-----------	---	----	----	----	----	----	----	----	----

Egendæmpning ΔL , [dB]

Ød nom	Ventil monteret i	Middelfrekvens [Hz]							
		63	125	250	500	1K	2K	4K	8K
100	Kanal	22	18	13	11	9	8	7	8
125	Kanal	20	16	11	9	9	7	6	5
160	Kanal	18	14	10	9	9	7	6	6

Tolerance	±6	±3	±2	±2	±2	±2	±2	±2	±3
-----------	----	----	----	----	----	----	----	----	----

Indregulering

Indreguleringsdata for kontrol af luftmængden findes i
 installationsvejledning.

Stråleudbredelse

Maksimal vertikal højde, b_v [m]:

Indstilling a [mm]	Δt	
	±0 °C	-10 °C
4	$b_v = 0,04 \cdot l_{02}$	$b_v = 0,064 \cdot l_{02}$
12	$b_v = 0,04 \cdot l_{02}$	$b_v = 0,075 \cdot l_{02}$

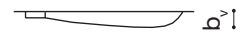

Maksimal horisontal bredde, b_h [m]:

Indstilling a [mm]	Δt	
	±0 °C	-10 °C
4	$b_h = 1,45 \cdot l_{02}$	$b_h = 1,15 \cdot l_{02}$
12	$b_h = 1,45 \cdot l_{02}$	$b_h = 1,09 \cdot l_{02}$

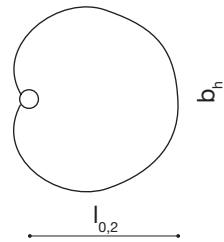

Ventil - tilluft

KIR

