



# Lindab **Professor XP**

Hurtig installationsvejledning



# Hurtig installationsvejledning

# Professor XP

## Symboler



Varmt vand



Håndkraft



Koldt vand



Tung last - 2 mands arbejde.  
Vi foreslår at anvende løfte lift  
for montering.

## Værktøj



Kniv



Handsker



Sko med bløde såler

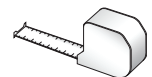

Målebånd

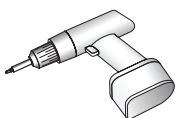

Skruemaskine

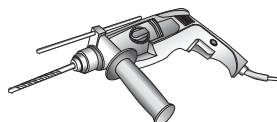

Boremaskine

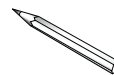

Blyant



Svensk nøgle

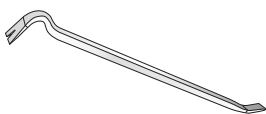

Koben

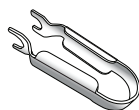

Tectite værktøj 12 mm  
Bestillingskode: 884087



Tectite værktøj lille 12 mm  
varenummer: 646881

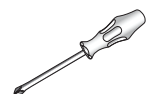

Skruetrækker

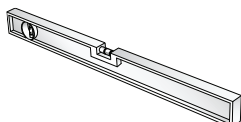

Vaterpas



Lindab PC410  
(varenummer: 103344)

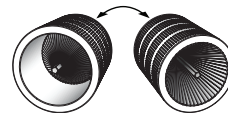

Afgratningsværktøj

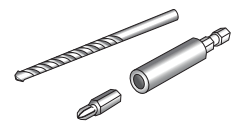

Bits og bor



Støvsuger



Blød børste

# Hurtig installationsvejledning

# Professor XP

## Retningslinjer for indpakning/udpakning

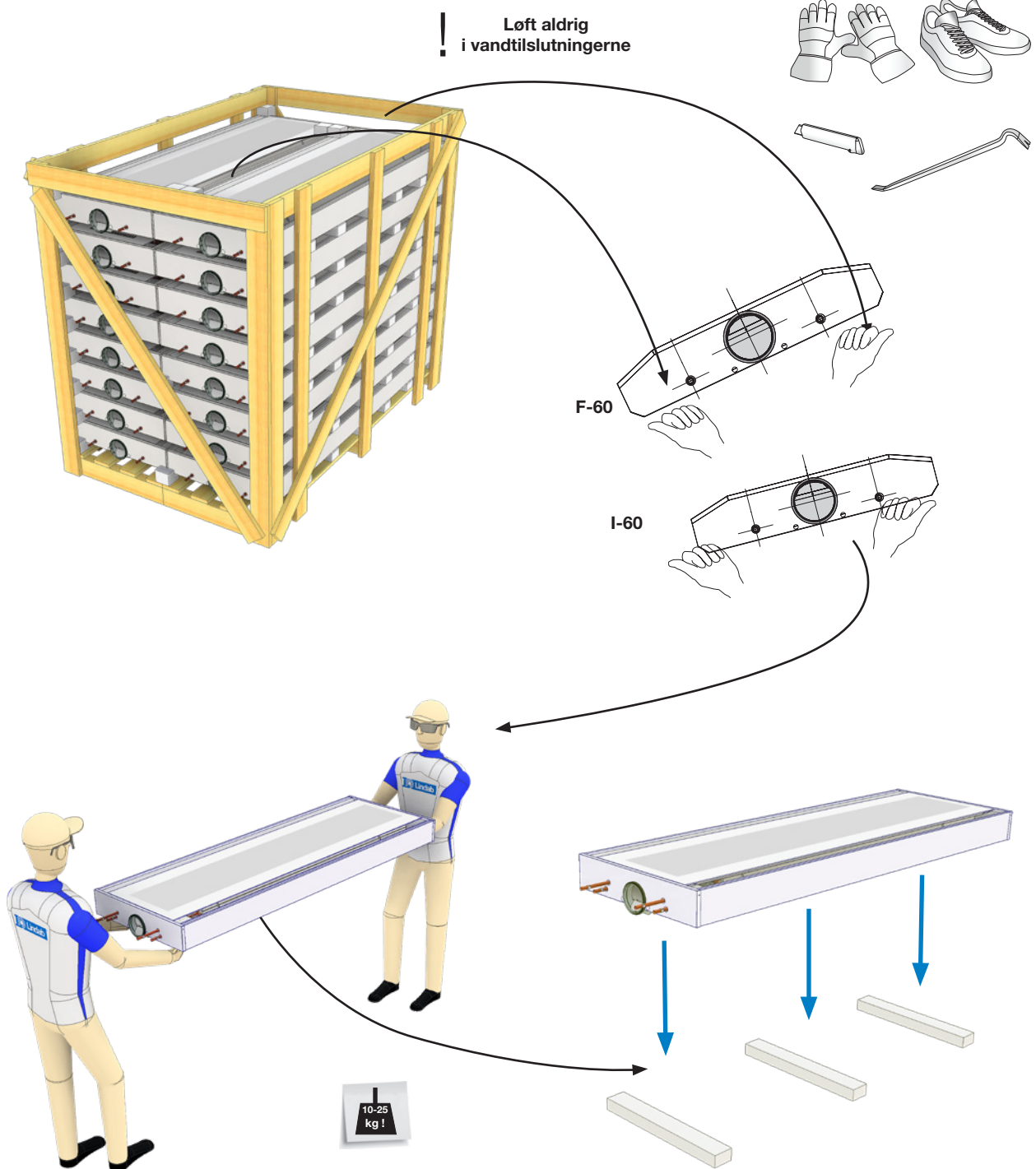

# Hurtig installationsvejledning

# Professor XP

## Bestillingskode

Order : xx-xxxxx  
 Pos : xx  
**PRO X-XX-12-xX100-xx-xxxx-x.x-xx-xx** x.x m  
 Pressure: AA Pa | Flow: BB l/s  
 Project : xxxxxxxx  
 Mark : xxxxxx  
 Nozzles : xx Plugs : xx Sign :  
 Product ID : xxxxxxxx



x2



Professor XP I-60

Date : | P<sub>stat</sub> [Pa] : | q<sub>v</sub> [l/s] : | Total open nozzles : | Signature : |

$q_{v/n} = \sqrt{\Delta P_{stat}}$   
 48  
 $\eta_{open} = \frac{q_v}{q_{v/n}}$

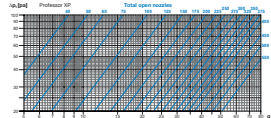
<b>PRO</b>	<b>X-XX</b>	<b>12</b>	<b>Xx100</b>	<b>XX</b>	<b>XXXX</b>	<b>X.X</b>	<b>XX</b>	<b>XX</b>
	I-45* I-60* F-45* F-60*	Ø12	1x100 2x100	A1 A2 A3 A4 B1 B2 B3 B4	0400 0600 0800 1200  0402 0602 0606 0802 0806 1202 1206	Nominel produktlængde [m]  1,2 m - 3,6 m i trin af 0,1 m	Statisk tryk dyser [Pa] 30-120 Pa	Primær luftmængde [l/s] 5-80 l/s

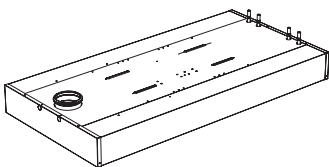

Order : xx-xxxxx  
 Pos : xx  
**PRO I-60-12-1x100-B4-1206-1,4-60-27** 1,4 m  
 Pressure: 60 Pa | Flow: 27 l/s  
 Project : Lindab luceremarken  
 Mark : I-60  
 Nozzles : B4 Plugs : 12 Sign :  
 Product ID : xxxxxxxx



→ PRO - I - 60 - 12 - 1x100 - B4 - 1206 - 1,4 - 60 - 27

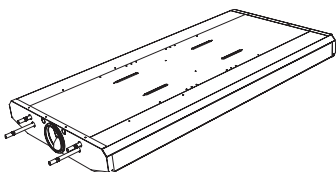

Order : xx-xxxxx  
 Pos : xx  
**PRO F-60-12-1x100-A1-0602-1,2-40-18** 1,2 m  
 Pressure: 40 Pa | Flow: 18 l/s  
 Project : Lindab luceremarken  
 Mark : F-60  
 Nozzles : A1 Plugs : 6 Sign :  
 Product ID : xxxxxxxx



→ PRO - F - 60 - 12 - 1x100 - A1 - 0602 - 1,2 - 40 - 18

## Hurtig installationsvejledning

## Professor XP

## Materiale data

## Materiale data

Type	Professor XP
Kobberrørs kvalitet	EN-12735-2 CU-DHP
Trykklasse	PN10

## Specifikke mål for vandkredsløbet

Ydeevne	Funktion	Batteri type CC HH	Tør vægt [kg/m]	Vandindhold Køling [l/m]	Vandindhold varme [l/m]	Vandindhold Total [l/m]
Maksimal køling og maksimal varme	4-rør	12 06	14,2	1,1	0,6	1,7
Maksimal køling og minimal varme	4-rør	12 02	13,7	1,1	0,3	1,4
Maksimal køling eller maksimal varme	2-rør	12 00	13,5	1,1		1,1
Høj køling og maksimal varme	4-rør	08 06	13,7	0,8	0,6	1,4
Høj køling og minimal varme	4-rør	08 02	13,2	0,8	0,3	1,1
Høj køling eller høj varme	2-rør	08 00	13,0	0,8		0,8
Medium køling og maksimal varme	4-rør	06 06	12,4	0,6	0,6	1,2
Medium køling og minimal varme	4-rør	06 02	11,9	0,6	0,3	0,9
Medium køling eller medium varme	2-rør	06 00	11,6	0,6		0,6
Minimal køling og minimal varme	4-rør	04 02	11,8	0,4	0,3	0,7
Minimal køling eller minimal varme	2-rør	04 00	11,5	0,4		0,4

## Miljøvare deklarerationer

Følg venligst nedenstående links

- [Byggevarer deklARATION](#)
- [Overensstemmelseserklæring](#)
- [Eurovent certifikat](#)

## Trykklasse

Samtlige produkter i Lindabs vandbårne sortiment (Køle/varme), produceres så de opfylder trykklasse PN10 i henhold til EN 1333: 2006.

Dette betyder, at det maksimale arbejdstryk for produkterne ved en vandtemperatur på 20°C, ikke må overstige 10 bar.

# Hurtig installationsvejledning

# Professor XP

## Dimensioner

**F-60**

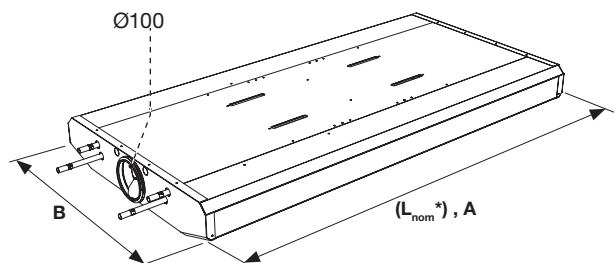

**I-60**

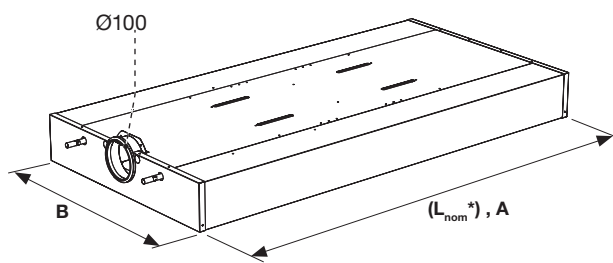

Alle vandtilslutninger  $\varnothing = 12$  mm, gå til side 8.

### F-modeller

**F-45**

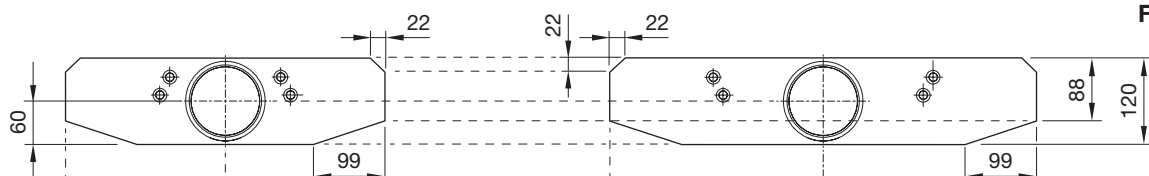

**F-60**

### I-modeller

**I-45**

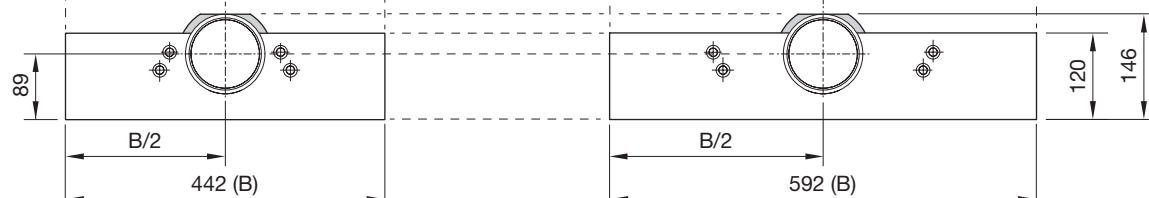

**I-60**

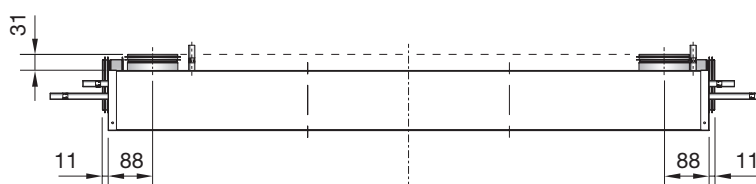

Professor XP	$L_{nom}^*$ [mm]	A [mm]	B [mm]	[kg / m]	Loft type
F-45	1200, 1300 ..... 3500, 3600 I trin af 0,1 m	1192, 1292, ..... 3492, 3592	442	Se tabel på side 5	Synlig
I-45					1
F-60			592		Synlig
I-60					1

\*  $L_{nom}$  = Nominel længde (bestillingslængde).

# Hurtig installationsvejledning

# Professor XP

## Dimensioner på vandrør og placering

Vandrørs dimensioner og placering for F-modeller og I-modeller.

Alle vandtilslutninger er  $\varnothing = 12$  mm

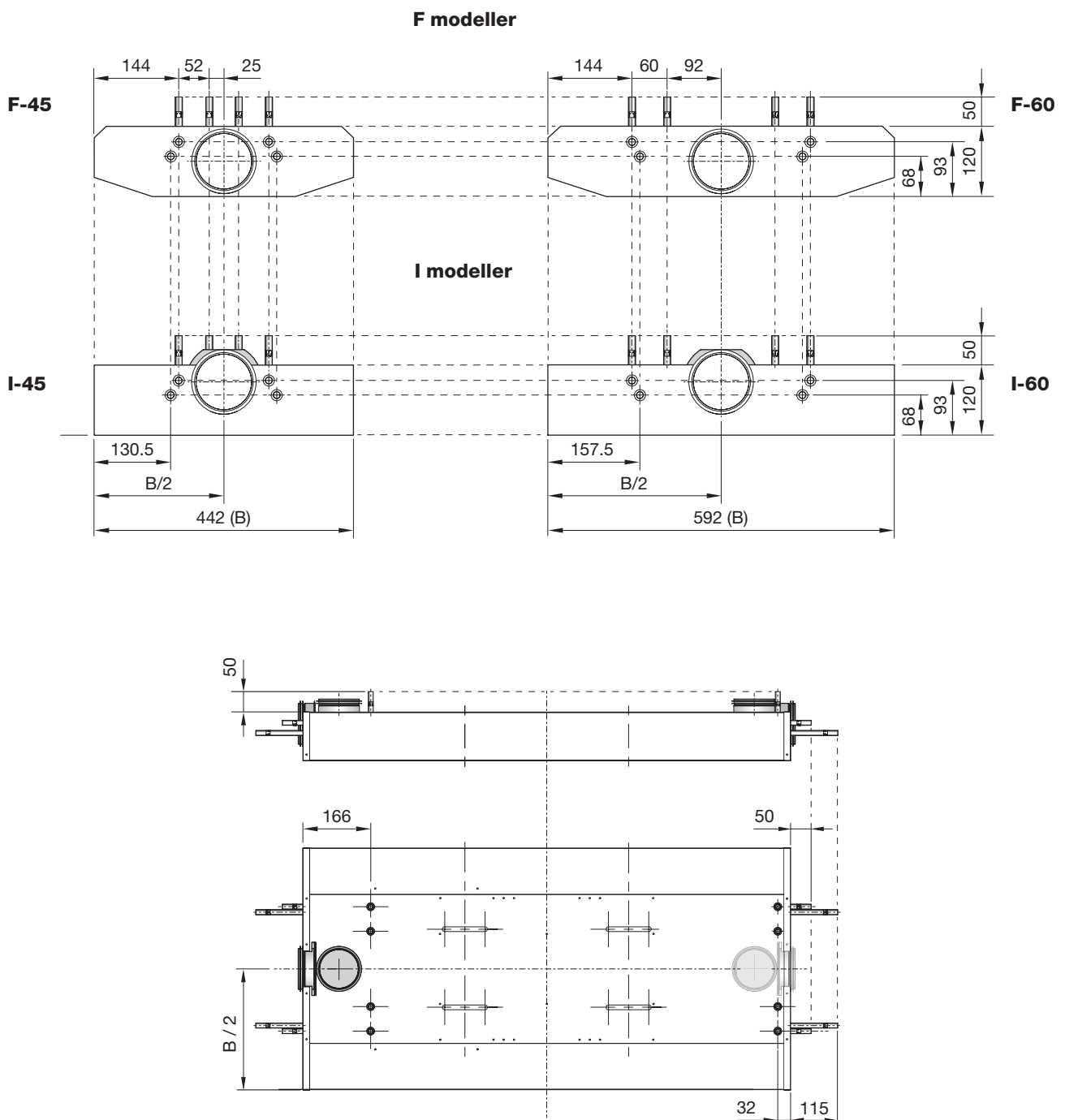

# Hurtig installationsvejledning

# Professor XP

## Vandtilslutninger

Professor XP: F-45, F-60, I-45 og I-60 køling eller opvarmning (2 rørs standard), I-62, J-60, K-60, L-60, X-60, Y-60 og Z-60 (Loftilpassede modeller).

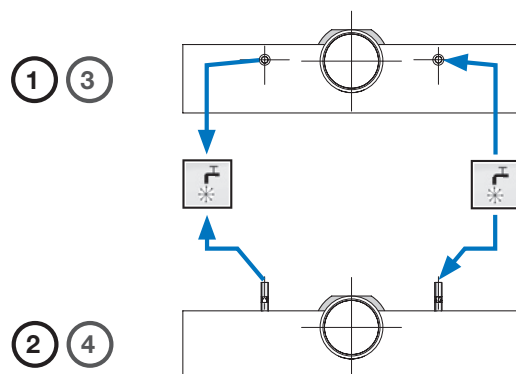
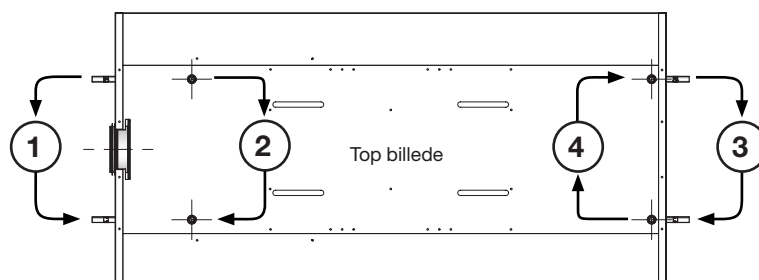

Professor XP: F-45, F-60, I-45 og I-60 køling eller opvarmning (4 rørs standard), I-62, J-60, K-60, L-60, X-60, Y-60 og Z-60 (Loftilpassede modeller).

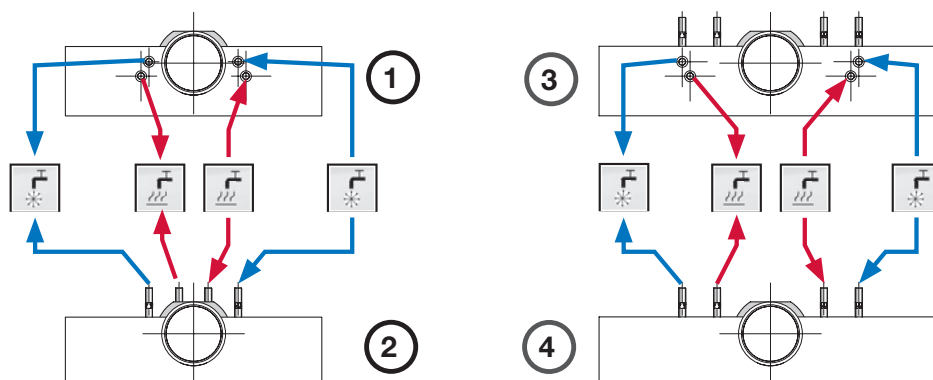
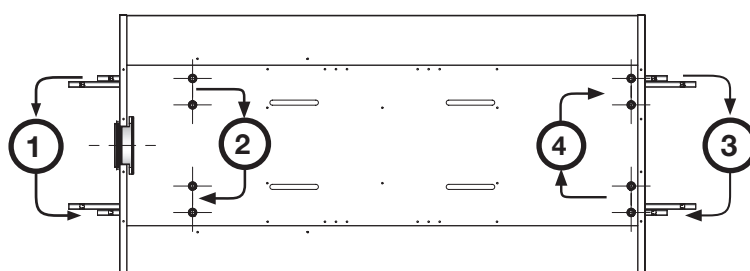



# Hurtig installationsvejledning

# Professor XP

## Regula komponenter og ventiler

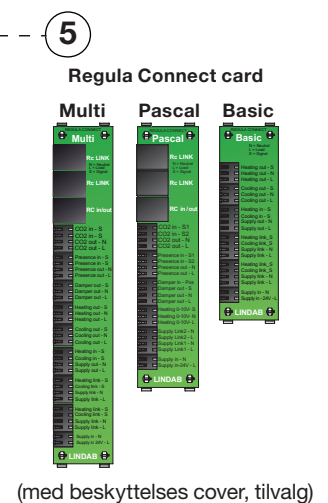
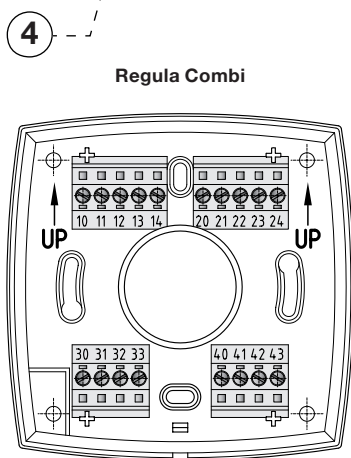
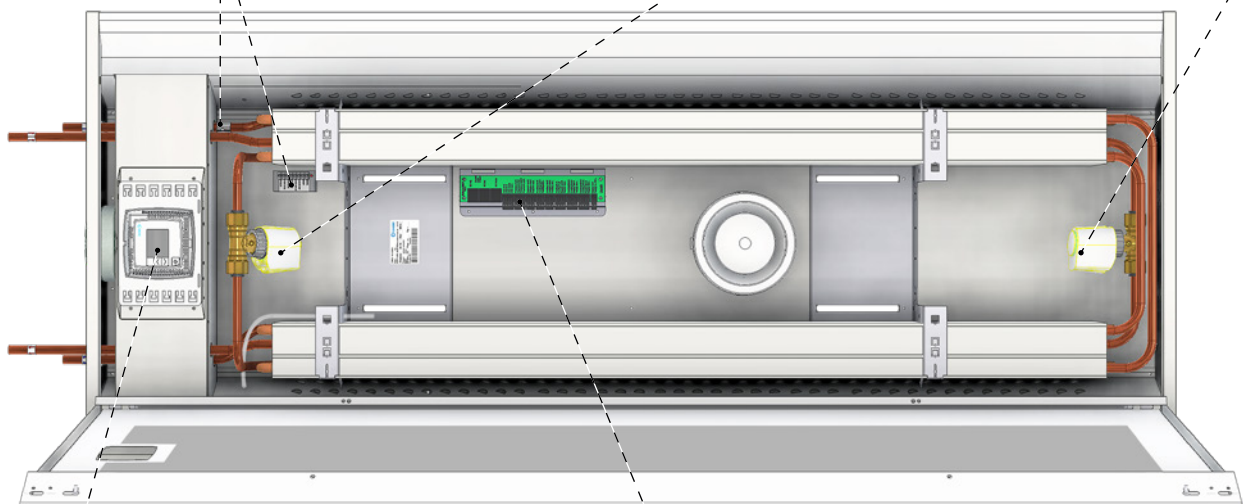
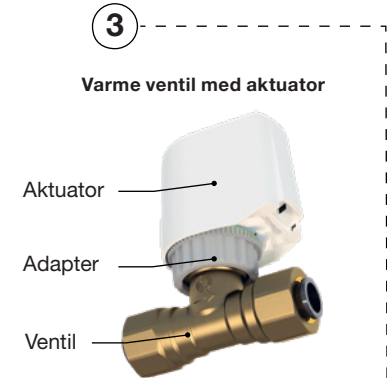
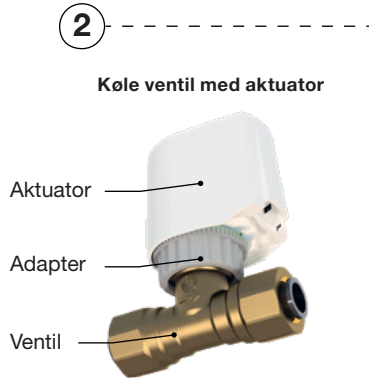
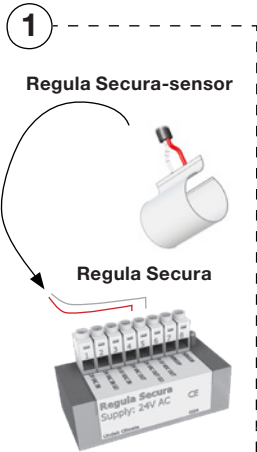

# Hurtig installationsvejledning

# Professor XP

## Før installation

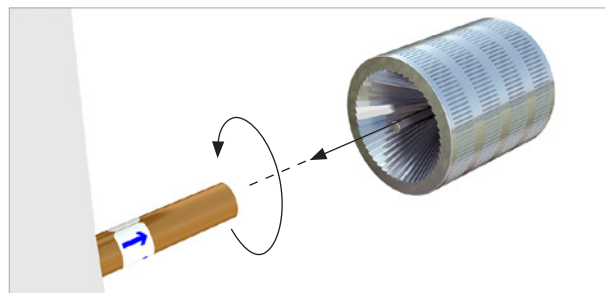
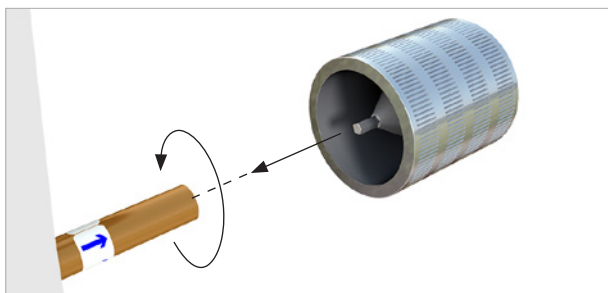
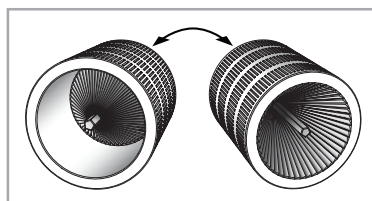
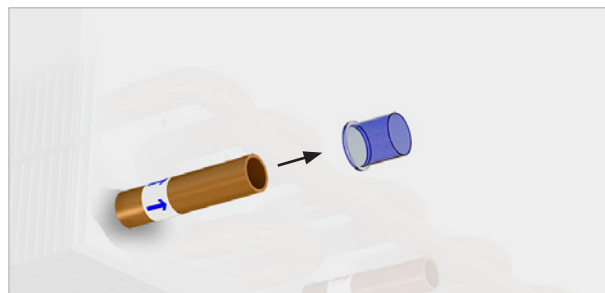

## Flex slanger og Push on ventiler

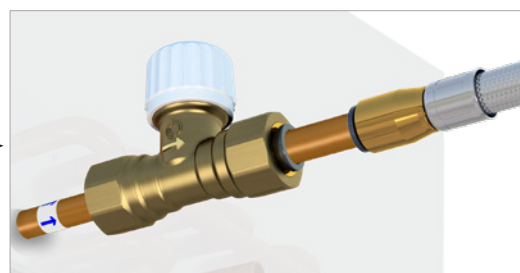
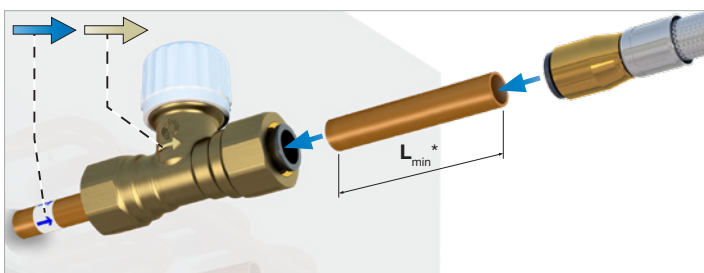
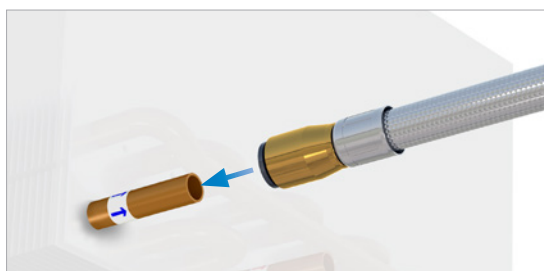

\*  $L_{min} = 70 \text{ mm}$  (for at sikre, at du kan åbne koblingerne igen).  
Lindab fleksible slanger fås med lige ende (har) til direkte forbindelse til Lindab ventiler også.

# Hurtig installationsvejledning

# Professor XP

## Forberedte montage tiltag på produktet

Kølebafflen er forberedt for montage med gevindstænger M8. 4 x M8 pr. kølebaffel når  $L_{nom} \leq 2700$  mm.  
6 x M8 pr. kølebaffel når  $L_{nom} > 2700$  mm.

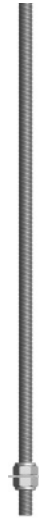
**M8**

## Tilslutningspunkter for gevindstænger, ikke flange modeller:

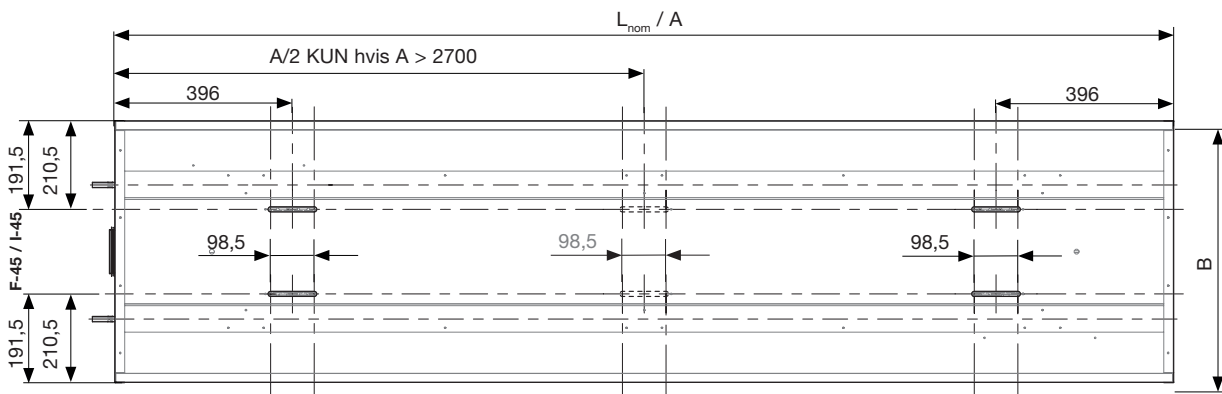
**F-45, F-60, I-45, I-60**
**I-62, Y-60, Z-60 (Lofttilpassede modeller)**

## Tilslutningspunkter for gevindstænger, flange modeller:

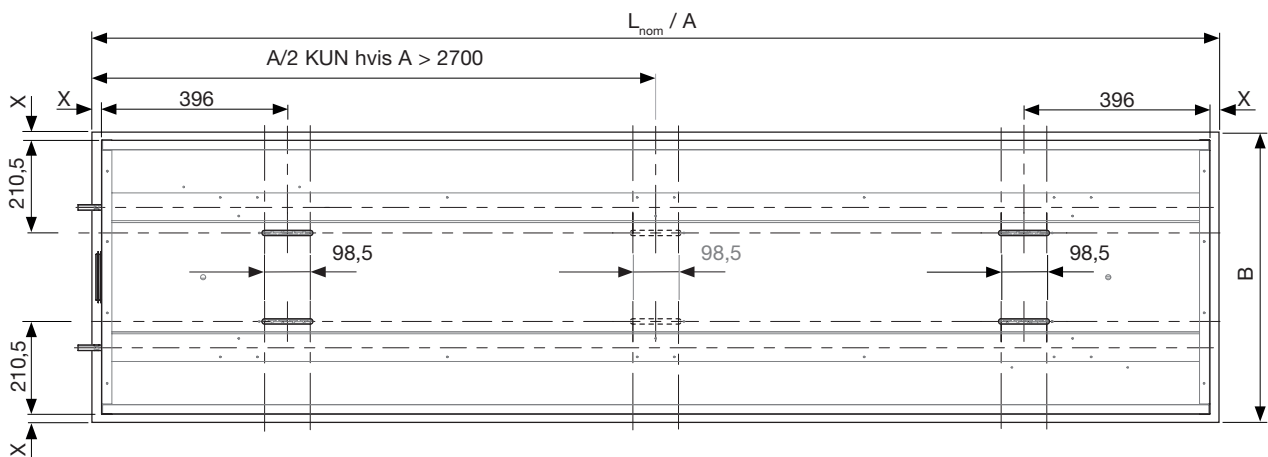
**J-62, K-60, L-60, X-60 (Lofttilpassede modeller)**

Professor XP	$L_{nom}$ * [mm]	A [mm]	B [mm]	X [mm]	Vægt specifikation [Kg / m]	Loft type
I-62	1200, 1800, 2400, 3000, 3600	1242, 1867, 2492, 3117, 3742	617	-	Gå til side 5 se tabel.	21
J-60		1192, 1792, 2392, 2992, 3592	592	22		8
K-60		1199, 1799, 2399, 2999, 3599	599	25,5		5
L-60		1224, 1824, 2424, 3024, 3624	624	16		3
X-60		1199, 1799, 2399, 2999, 3599	599	25,5		4, 6, 7, 14
Y-60		1175, 1775, 2375, 2975, 3575	575	-		9, 11
Z-60		1184, 1784, 2384, 2984, 3584	584	-		10

\*  $L_{nom}$  = Nominal længde (bestillings længde).

\*\* X = Flange dimension. - = ingen flange

# Hurtig installationsvejledning

# Professor XP

## Installation

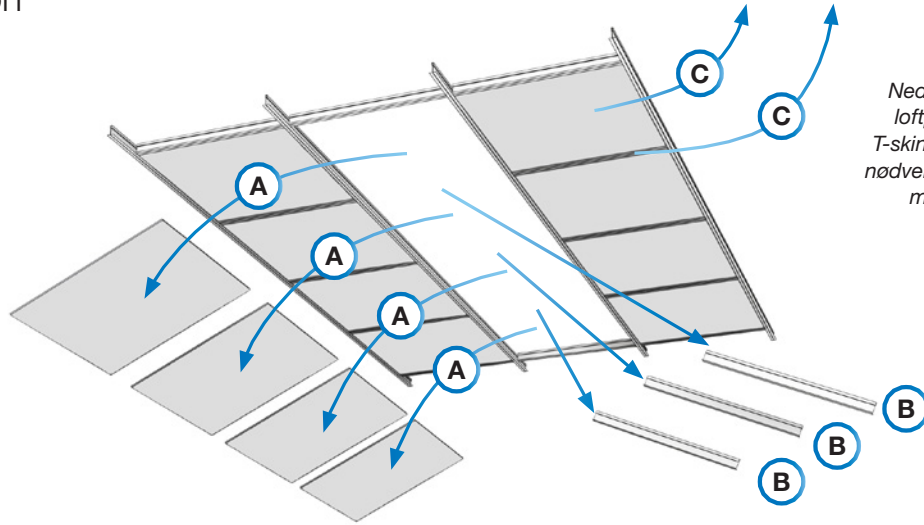

Nedtag ekstra loftplader og T-skiner for at få nødvendig plads til montage.

**(D)**  
 For at finde tilslutningspunkter for gevindstænger, se dimensioner, tegninger og tabel på forrige side over alle Professor XP modeller.

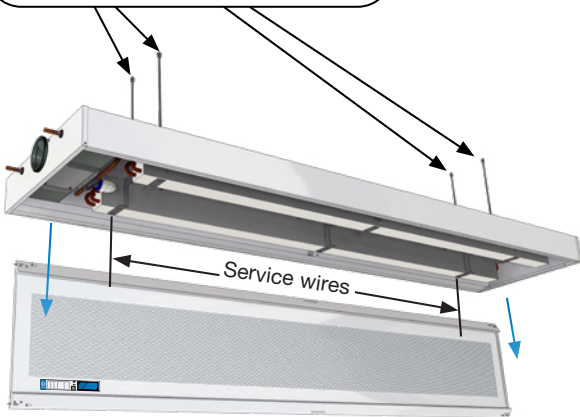
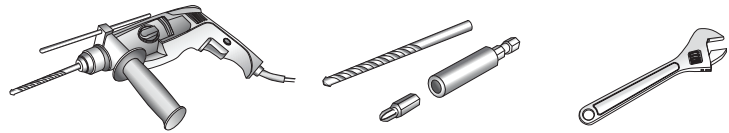

Lindab anbefaler at fjerne bundpladen helt før enheden installeres i loftet. Gå til side 14, vedligehold (F-modeller) og side 15 (Øvrige modeller). Se "Åbning af bundplade".

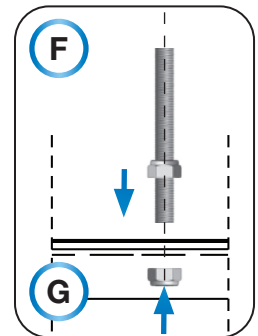
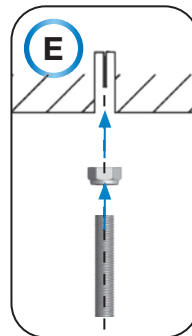

**Tung last! !**  
 Den længste Professor XP er 3,6 m med en vægt på ca. 52 kg.  
 Anvend professionelt løftegrej.

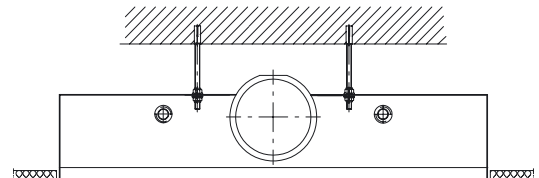
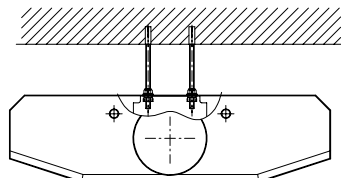
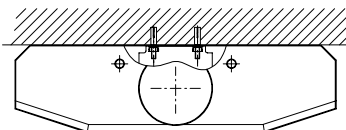
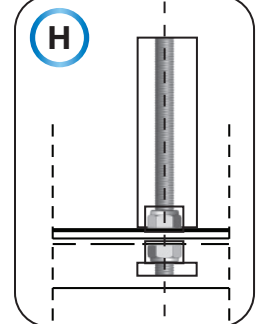

# Hurtig installationsvejledning

# Professor XP

## Måling af statisk dysetryk og lufttryk

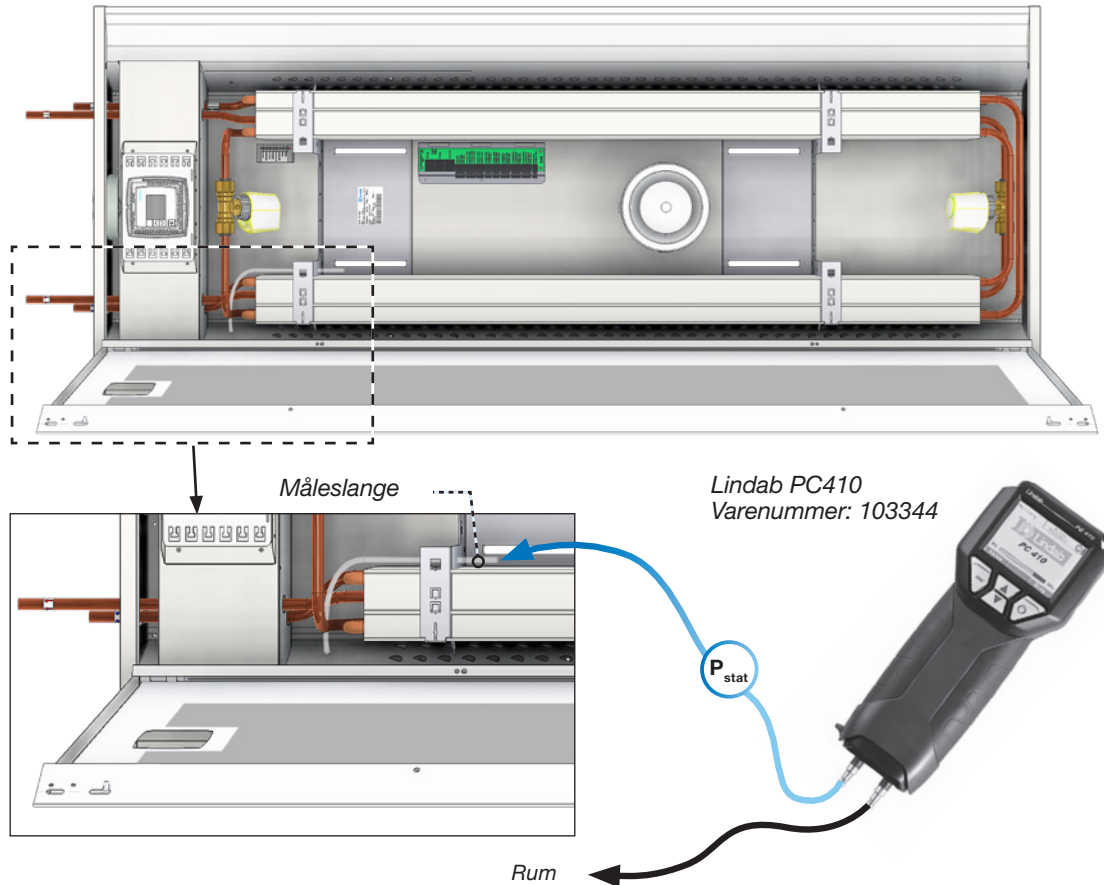

### Eksempel på anvendelse af diagram 1

Professor XP: PRO-I-60-12-1x100-A1-1200-2,4-60-35

$\Delta p_{stat} = 60 \text{ Pa}$  (statisk tryktab)

$n_{\text{åben}} = 217 \text{ pcs.}$

$\Rightarrow q_a = 35 \text{ l/s}$  primær luftmængde

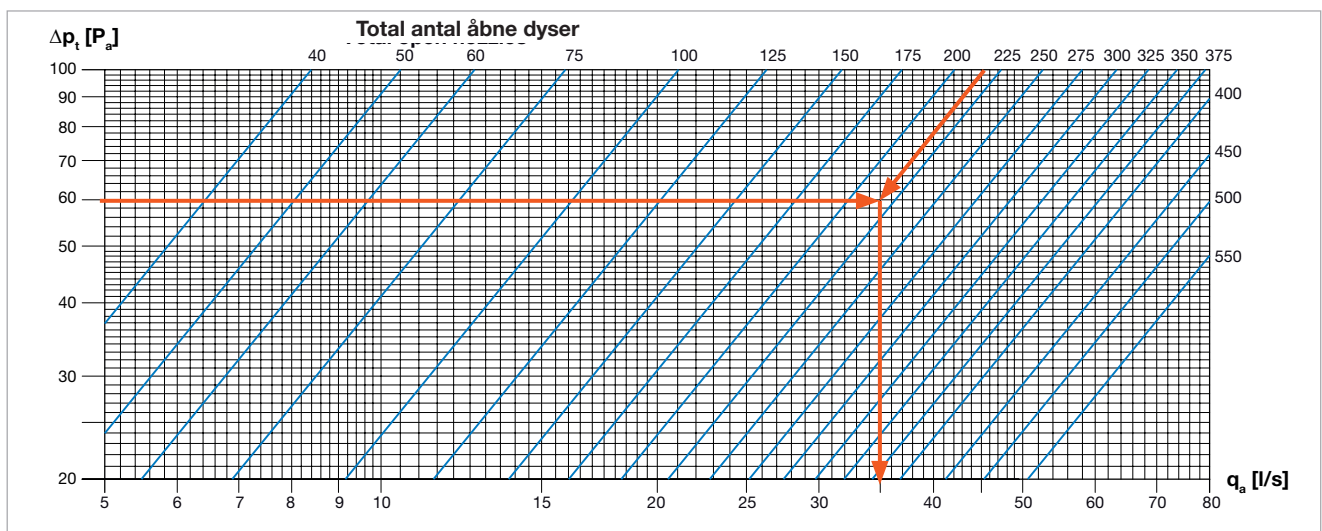



# Hurtig installationsvejledning

# Professor XP

Vedligehold F-modeller

Åbning af bundplade

F-45 / F-60

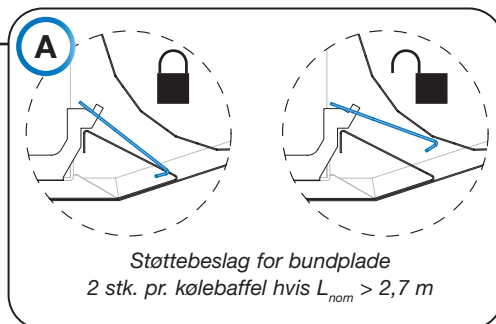
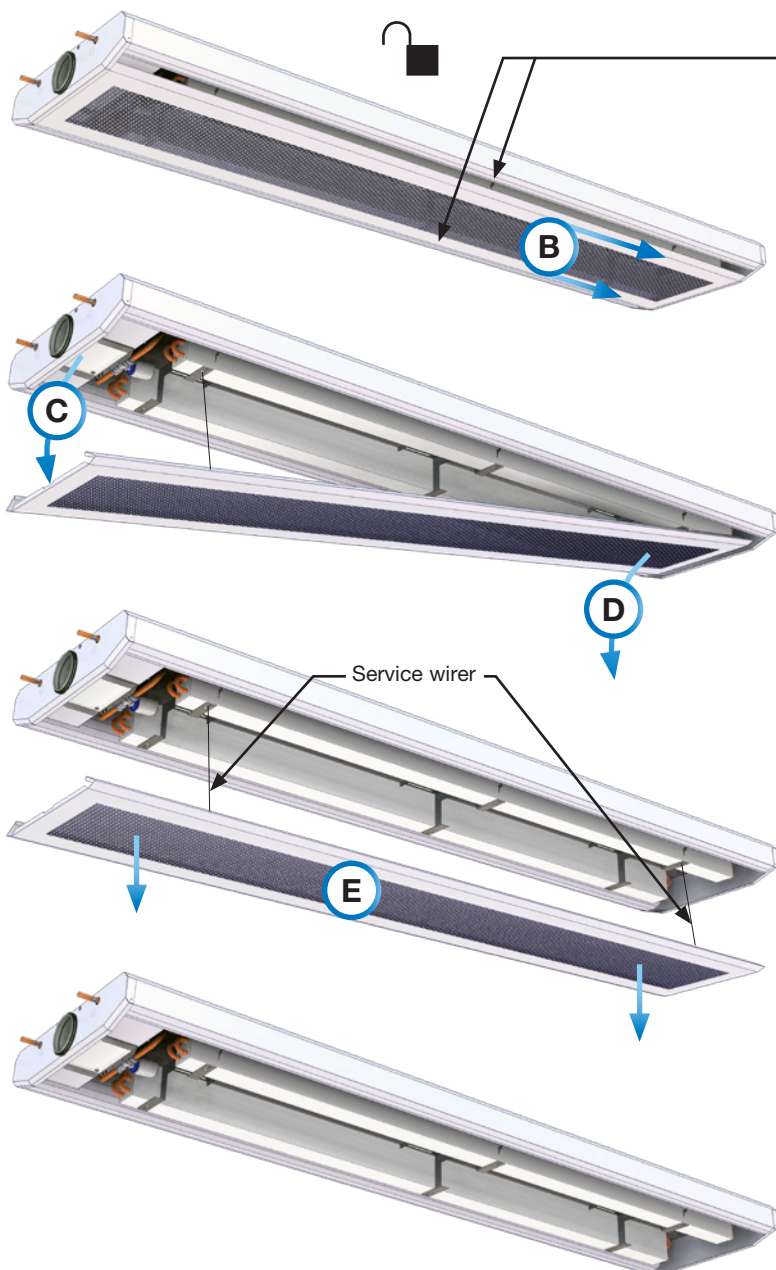

Bundpladen hænger nu i service wirer. Underpladen kan fjernes helt ved at løsne den fra service wirerne.

Følg de viste trin i omvendt rækkefølge (E- A) for at geninstallere bundpladen.

# Hurtig installationsvejledning

# Professor XP

Vedligehold øvrige modeller

I-45 / I-60 .

Gælder også for loft tilpassede modeller I-62, J-60, K-60, L-60, X-60, Y-60 og Z-60.

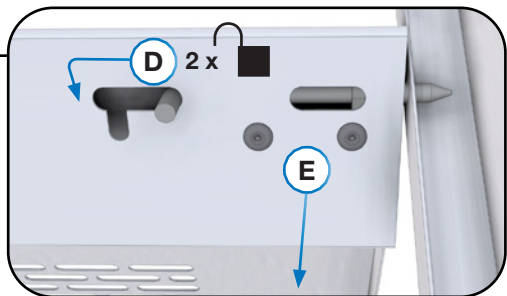
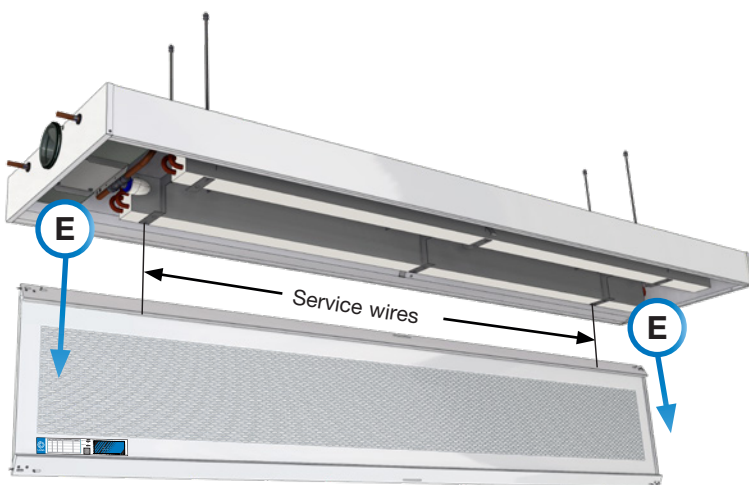
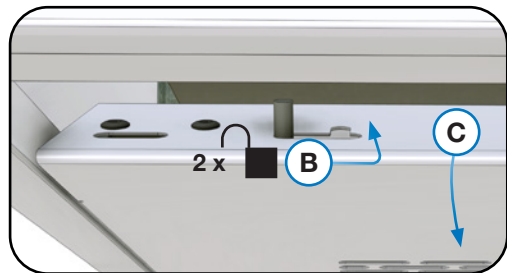
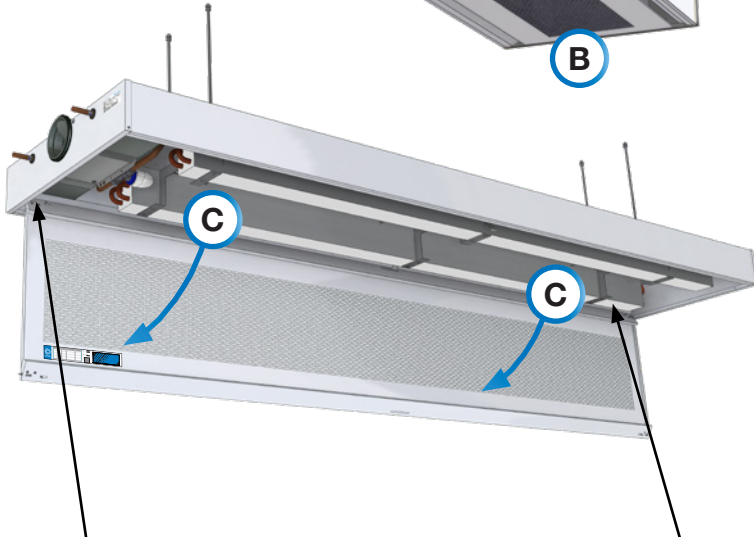
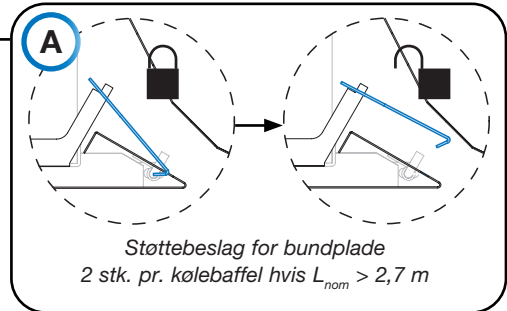
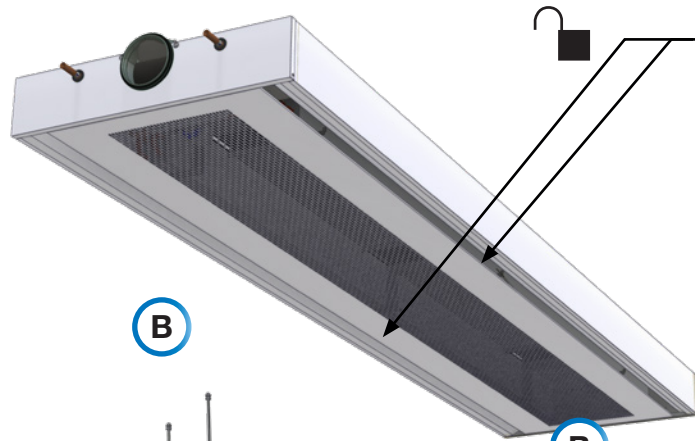

Bundpladen hænger nu i service wire. Underpladen kan fjernes helt ved at løsne den fra service wire.

Følg de viste trin i omvendt rækkefølge (E- A) for at geninstallere bundpladen.



De fleste af os tilbringer størstedelen af vores tid indendørs. Indeklima er afgørende for, hvordan vi har det, hvor produktive vi er, og om vi holder os sunde.

Hos Lindab har vi derfor gjort det til vores vigtigste mål at bidrage til et indeklima, der forbedrer menneskers liv. Det gør vi ved at udvikle energieffektive ventilationsløsninger og holdbare byggeprodukter. Vi stræber også efter at bidrage til et bedre klima for vores planet ved at arbejde på en måde, der er bæredygtig for både mennesker og miljøet.

[Lindab | For et bedre klima](#)